

# aLL-PRO CORNER™

## Installation Guide



# TandoStone® System Installation Guide

## System Components

**TandoStone® Stacked Stone Panel**

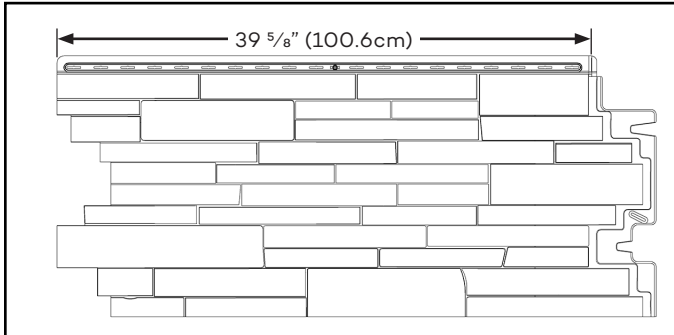

**TandoStone® Universal Starter Strip**

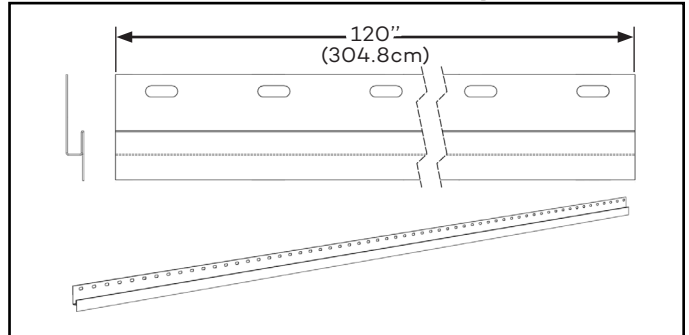

**TandoStone® aLL-Pro Corner™ - "A"**

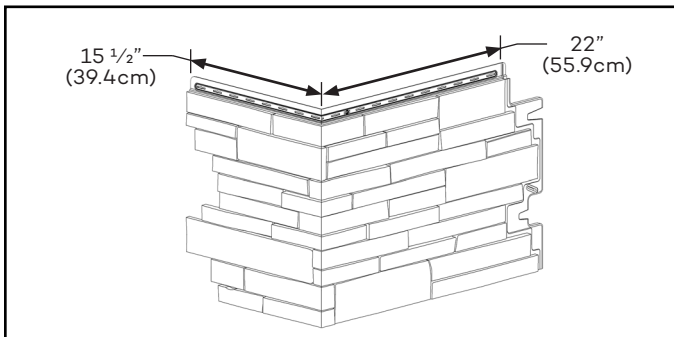

**TandoStone® aLL-Pro Corner™ - "B"**

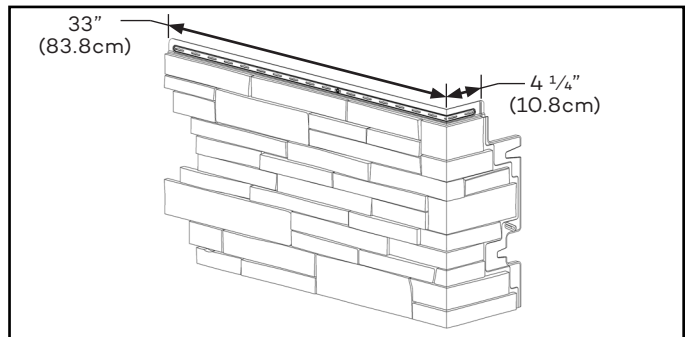

**Architectural Sill**

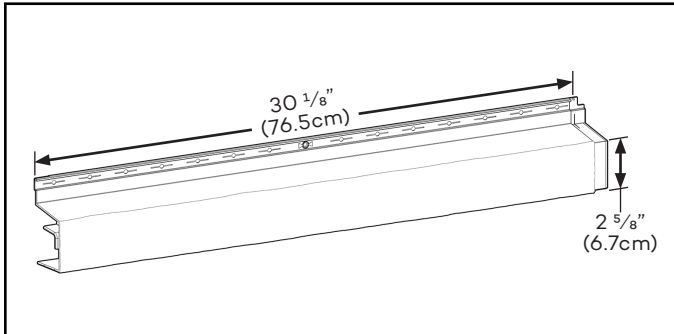

**Architectural Sill Corner**

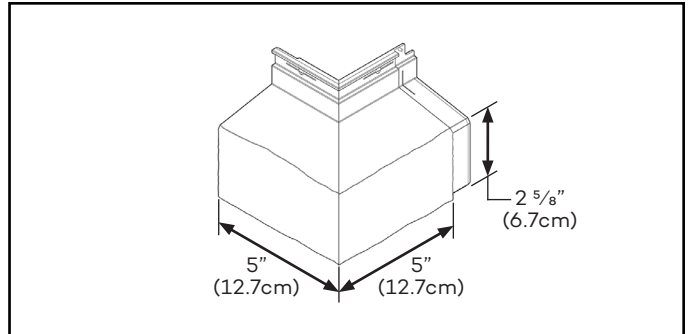

**TandoStone® Kut Kit™ contents:**

**Kut Kit Caulk & Kut Kit Crimp Plates**

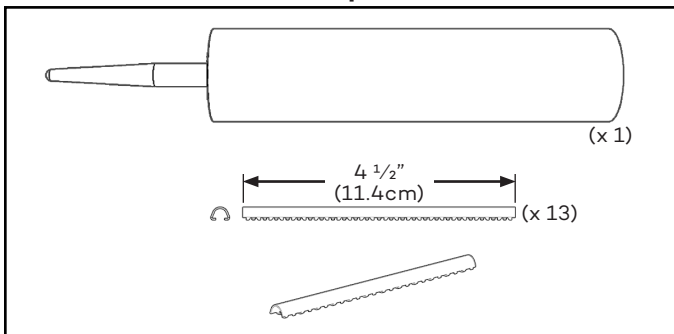

# TandoStone® System Installation Guide

## Understanding the TandoStone Panel

Each TandoStone Stacked Stone panel has a NAILING FLANGE across top of the panel.

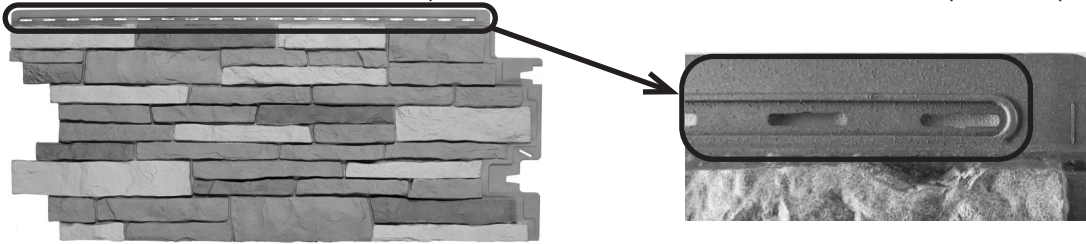

Within each nailing flange, are NAILING SLOTS. Around the nailing slots is a RAISED RADIUS EDGE.

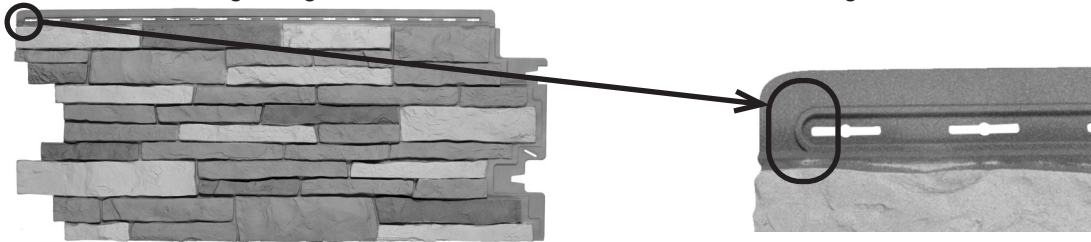

Each panel has a TEMPERATURE GAUGE on the right side.

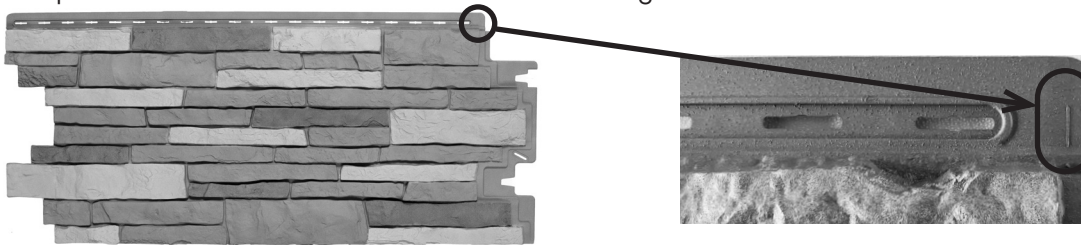

All panels have SIDE LOCKS located at the upper and lower areas of left and right panel sides.

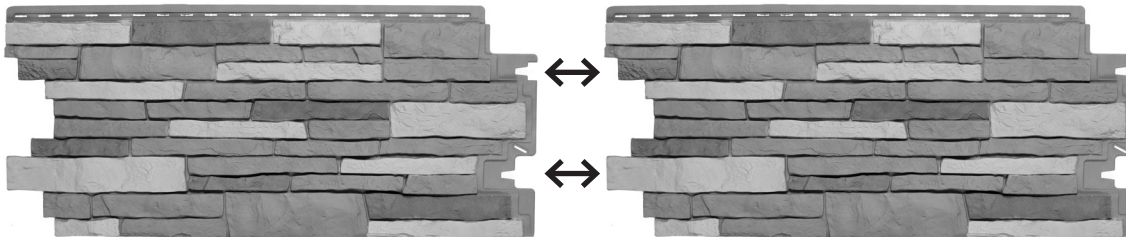

The back of each panel has 9 HOOKS spaced across the lower edge of panel.

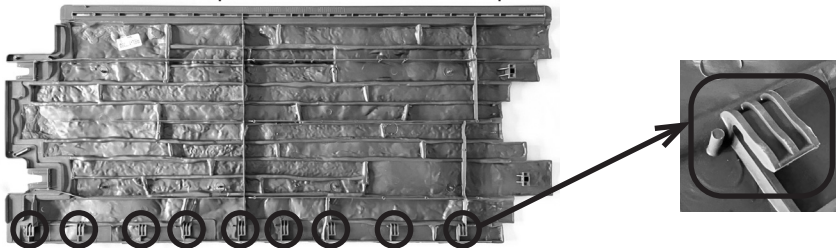

The back of each panel has 2 SPINES (running vertically) and 3 RIBS (running horizontally).

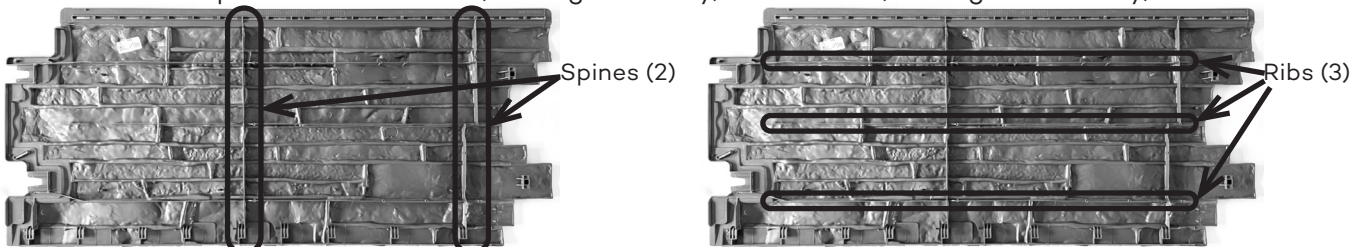

# TandoStone® aLL-Pro Corner™

## Installation Guide

### GENERAL INFORMATION

- All TandoStone system components are manufactured by Derby Building Products in an ISO-certified facility and carry all major code listings (ICC, FBC, and CCMC).
- Variations in shade and color are designed into the TandoStone system to replicate authentic stone and stone veneer.
- TandoStone system components should be installed using proper building practices and in accordance with the local building codes and the installation guidelines that follow.
- The TandoStone system may not be suitable for every application and it is the sole responsibility of the installer to ensure that it is fit for the intended use. Tando Composites accepts no liability for the improper installation of this product.
- It is best practice before beginning any project to have all applications reviewed by an architect, engineer, or local building official.
- If you have any questions or need further assistance, please visit our website at [www.TandoComposites.com](http://www.TandoComposites.com).

### INSTALLATION OVERVIEW

- The TandoStone system is intended for use in a side-wall application only. It is not designed or warranted for roofing or flooring applications.
- The TandoStone system is designed to be installed on a flat, smooth, solid wall (e.g., OSB or plywood) surface.
- The TandoStone system is designed as an exterior cladding, not a weather-resistant barrier. We recommend a weather-resistant barrier, such as a house wrap, be used in conjunction with the TandoStone system. As always, follow local building codes.
- When applying fixtures, always use a solid support or specifically designed mounting blocks. Follow the mounting block manufacturer's installation instructions. Fixtures should not be installed directly to the aLL-Pro Corner or TandoStone.
- Non-corrosive fasteners are required.
- Begin the installation at the lowest point of the side wall, working from left to right installing one row at a time.
- There is a sticker containing a production "REL" number on each box and the back of each panel. Keep the REL number (ex: REL-123456) for future reference.



### STORAGE AND HANDLING

- Each aLL-Pro Corner box contains 4 corners - 2 "A" and 2 "B" corners.
- A box of TandoStone Stacked Stone contains 10 panels.
- Boxes of aLL-Pro Corner and TandoStone must be kept dry.
- Store boxes upright according to the directions on the box. Do not store corners or panels lying flat.
- TandoStone and the aLL-Pro Corners are engineered with innovative, high-tech coatings. When handling, use care not to gouge or scrape the exposed (front) product surface.



# TandoStone® aLL-Pro Corner™ Installation Guide

## TOOLS REQUIRED

- In addition to the standard tools that would be needed to install TandoStone (i.e., measuring tape, hammer, square, drill, hammer, saw, etc.), a caulk gun and linesman crimpers and/or pliers will be necessary to install the aLL-Pro Corner.



Standard tools



Caulk gun



Linesman crimpers, duct crimpers, or pliers

## WALL PREPARATION

- The TandoStone system is to be installed over a smooth, flat surface.
- We recommend a weather-resistant barrier, such as a house wrap, be used in conjunction with the TandoStone system. As always, follow local building codes.
- Unlike stone or stone veneer, the TandoStone system is designed to allow proper drainage and breathability without the need for supplemental rain screens.

## STARTER STRIP INSTALLATION

- Starter strips must be installed at the base of every wall.
- **When installing the aLL-Pro Corner, ensure the starter strip is extended to the end of each wall.**
- **Ensure the Starter Strip is level.**
- If there is a floor against the wall, install the top of the starter strip at 2 1/8" (5.4cm) above the floor.
- If there is no floor, mount starter strips flush with the base of the wall.
- Install starter strip using standard roofing nails.
- Fasteners should be flush to the surface and no more than 8" (20.3cm) apart.
- Continue installing across the wall area by placing the next starter strip in line with the previous one.
- Be sure to align starter strips on adjacent walls.

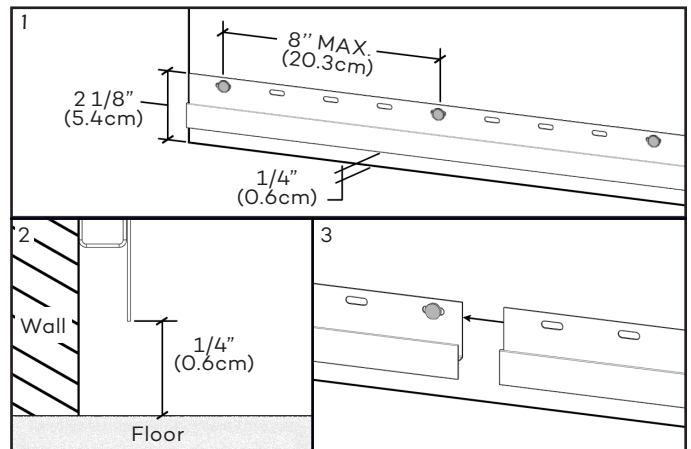

## CUTTING

- For best results use carbide-tipped blades with 8 teeth or more per inch.
- Panels should be cut face up.
- The aLL-Pro Corner and TandoStone panels are dense and rigid as they are a composite. Snips can be used, but cutting with snips will be harder. Snips should not be used to cut panels to fabricate a Kut Panel or Kut Panel XL.

# TandoStone® aLL-Pro Corner™

## Installation Guide

### FASTENERS

- Standard size roofing nails are recommended.
- For best results use galvanized or stainless steel fasteners.
- Fasteners should be at least 1 ½”(3.8cm) in length and penetrate into solid wall surface (e.g., OSB or plywood) by at least 7/16”(1.1cm).
- Never install fasteners flush, with the exception of the center hole fastener.
- Always leave a gap of 1/16”(0.2cm) between the nailing channel and the fastener head.

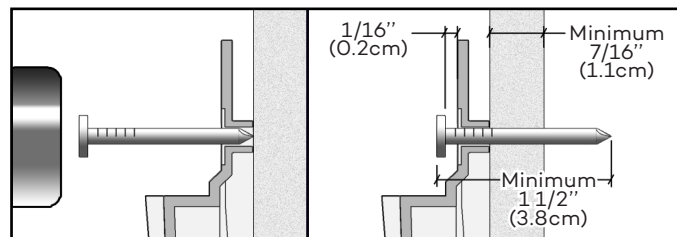

### FASTENING

- The first two fasteners are placed in each nailing slot closest to the corner.
- Next, two fasteners are placed in the last nailing slot on both ends of the aLL-Pro Corner.
- Continue installing fasteners across the nailing flange, no more than 8” apart.
- **Do not use the manufactured center nail hole on the aLL-Pro Corner.**
- Last, install one fastener in lateral nailing slot.
- Up to 9 fasteners will be used in an aLL-Pro Corner installation (8 fasteners in the nailing flange and 1 in the lateral nailing slot).
- NOTE:
  - When fastening through insulation or foam, increase the length of the fastener to account for the additional thickness of the insulation or foam.
  - If TandoStone and the aLL-Pro Corner are installed on a wall with furring strips, furring strips should be installed on a 45° angle, 8”(20.3cm) center to center, and a furring strip is required behind each fastener.

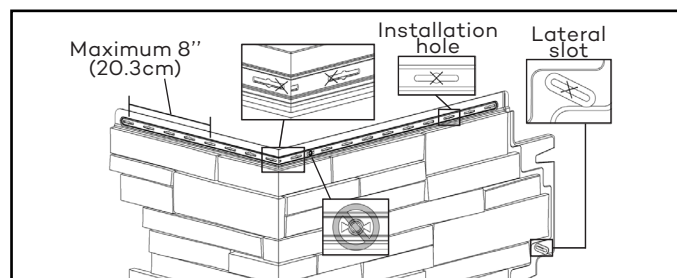

### TEMPERATURE GAUGE

- TandoStone panels and aLL-Pro Corners have a temperature gauge in the upper right corner.
- In most installations (outdoor temperature above 30°F/-1°C), position the TandoStone panel so its upper left edge meets the temperature gauge on the aLL-Pro Corner's nailing flange.
- In cold weather installations (below 30°F/-1°C), position the TandoStone panel 1/16”(0.2cm) to the right of the temperature gauge on the aLL-Pro Corner.
- Once a panel has been properly spaced, fasten it as previously indicated. Repeat this step until one last panel, either a full panel or a fabricated Kut Panel, is needed to complete the row.
- See instructions for making a Kut Panel on page 10.

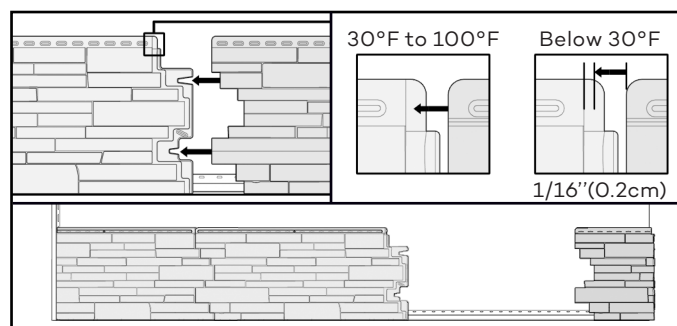

# TandoStone® aLL-Pro Corner™

## Installation Guide

### PLANNING THE aLL-PRO CORNERS LAYOUT - BASIC GUIDELINES

- **NOTE:** aLL-Pro Corners are installed prior to TandoStone panels.
- There are 2 models of the aLL-Pro Corner - "A" and "B".
- Either model can be used on either end of a wall.
- In many applications, the TandoStone system using the aLL-Pro Corner and TandoStone panels will be installed on walls with windows or doors. In these instances, full panels may be cut and terminated at the window or door.
- To ensure proper corners layout on a complete course when there are no windows or doors, use the following procedure:
  - **Always establish a proper first row layout before beginning installation.**
  - Dry fit an "A" corner on both left and right sides of the wall.
  - Measure the opening between the edges of the nailing flanges of the left "A" corner and the right "A" corner.
  - This opening measurement will determine the number of full 40"(101.6cm) TandoStone panels that will be needed.
  - After determining the number of full 40"(101.6cm) panels, any remaining space will require a "Kut Panel".
  - **NOTE:** Every Kut Panel MUST be 12"(30.5cm) or more.
  - Most installations using an "A-A" corner layout will have a Kut Panel of 12"(30.5cm) or more.
  - If the remainder is under 12"(30.5cm), change the corner layout from "A-A" to "A-B".
  - In these cases, switching from an "A-A" to an "A-B" layout will result in an opening over 12"(30.5cm). As best practice, double check the opening width.
  - See instructions for making a Kut Panel on page 10.

#### EXAMPLE:

- Opening between the left and right "A" corner flanges = 83"(210.8cm).
  - 83"(210.8cm) opening will use 2 full 40"(101.6cm) panels with a remainder of 3"(7.6cm).
  - This will not work as the remainder is less than 12"(30.5cm).
  - In this instance, change the right corner to a "B" corner. Now, instead of an "A-A" corner layout, you have an "A-B" layout
  - Measure again between the nailing flanges of the left "A" corner and the right "B" corner. This opening is 65"(165.1cm).
  - 65"(165.1cm) will use 1 full panel with a remainder of 25"(63.5cm) which is a perfect size for a Kut Panel.
- Once the first row is established, you must alternate corners on the second course. For example, if you used "A-A" on the first course, you will use "B-B" on the second course. If you used "A-B", then your second course will be "B-A". Continue to alternate as you move up the wall.

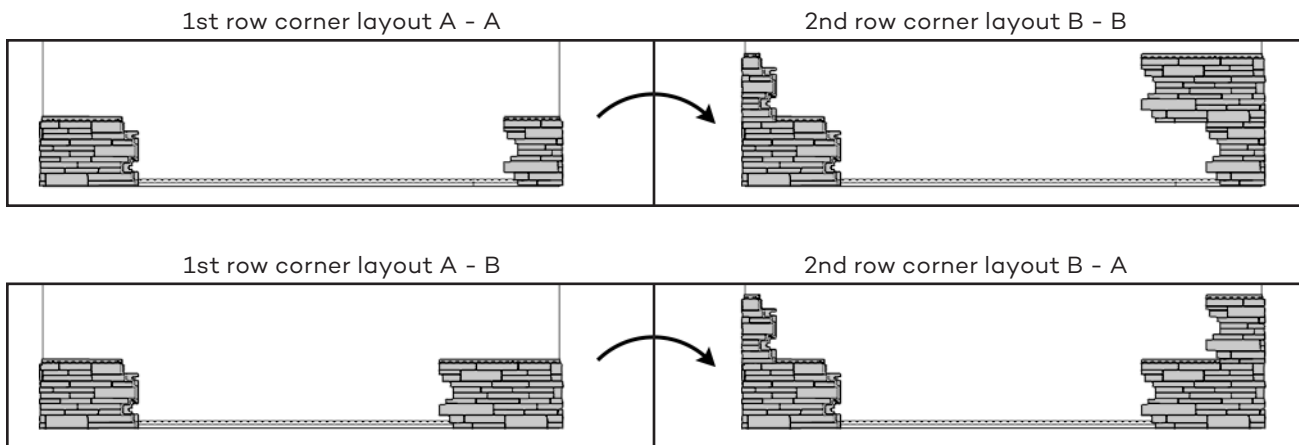

# TandoStone® aLL-Pro Corner™

## Installation Guide

### aLL-PRO CORNER ON RIGHT TO AN EDGE (J-CHANNEL/TRIM) ON LEFT SIDE OF THE WALL

- Plan the aLL-Pro Corner layout based on complete TandoStone installation.
- Temporarily dry fit the aLL-Pro Corner on the right side of the wall using screws.
- Measure wall length from the left end of the aLL-Pro corner and determine how many full panels can be used along with the length of panel that will be cut to fit into the j-channel trim on far left end of the wall.

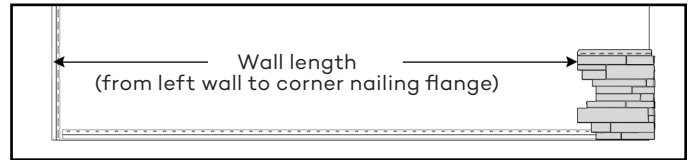

- Cut a panel to fit into j-channel/trim based on measurement above, slide cut panel into place while engaging hooks on the starter strip.
- Leave a 1/4" (0.6cm) space between the inside wall of the trim and cut panel.
- Fasten as described on page 6.

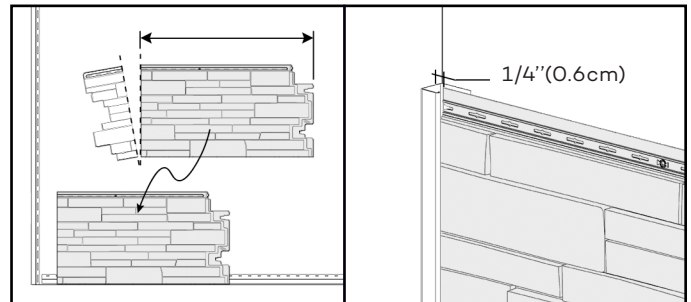

- Install the next full panel by hooking it onto the starter strip and sliding it to the left inserting the two side locks into the first panel.

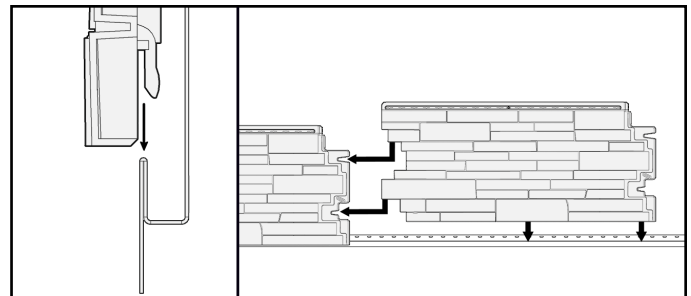

- Space subsequent panels according to the outdoor temperature during the installation as detailed on page 6 and nail in place.
- Repeat this step until one last panel is remaining to complete the row.
- Remove the temporarily installed corner.
- Install the last complete panel of the row.
- Reinstall the aLL-Pro Corner making sure to properly engage all hooks and tabs into starter strip and previous panel.
- Fasten corner into place using nails.
- Repeat those steps for all subsequent rows up the wall.
- Make sure to alternate the corner type used on each row as described on page 7.

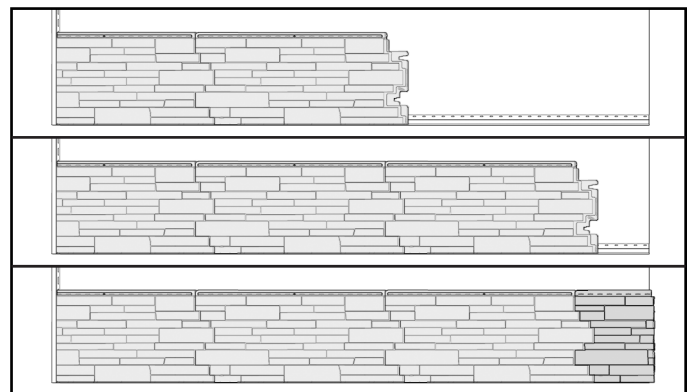



# TandoStone® aLL-Pro Corner™

## Installation Guide

### aLL-PRO CORNER ON LEFT TO AN EDGE (J-CHANNEL/TRIM) ON RIGHT SIDE OF THE WALL

- Install the first aLL-Pro Corner onto starter strips and fasten it on wall as described on page 6.

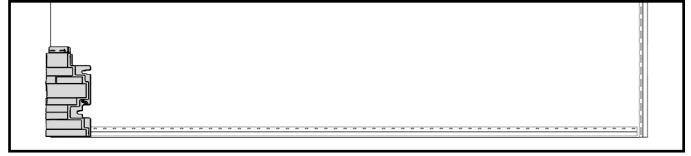

- Place a TandoStone panel on the starter strip to the right of the corner and slide left to engage the two side locks into the corner.
- Space panel from corner according to the outdoor temperature as described on page 6 and fasten in place with nails.

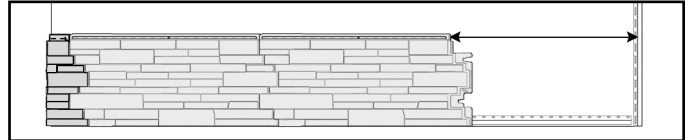

- Repeat this step until the remaining distance to the wall or j-channel/trim will not accommodate a full panel.

- Measure the length to finish the row. Cut and remove the last panel's right side to fill the space.
- Install it on starter strip and slide it into previous panel with proper spacing
- Fasten with nails as described on page 6.
- Repeat these steps for all subsequent rows.
- Make sure to alternate the corner used on each row as described on page 7.

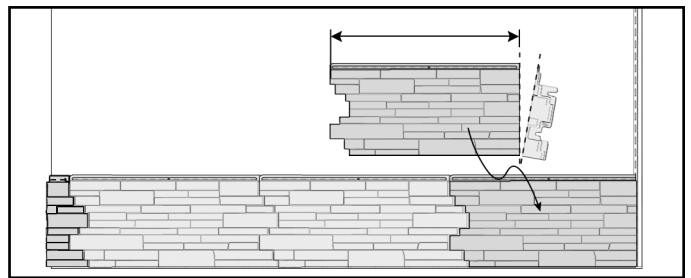

# TandoStone® aLL-Pro Corner™

## Installation Guide

### aLL-PRO CORNER ON BOTH ENDS OF THE WALL

#### INSTALLING CORNERS:

- Based on the corner layout described on page 7 install the aLL-Pro Corner at left end of the wall.
- Engage left side corner onto starter strips and nail to wall as described on page 6.
- Using screws, temporarily install the other aLL-Pro Corner on right end of wall.

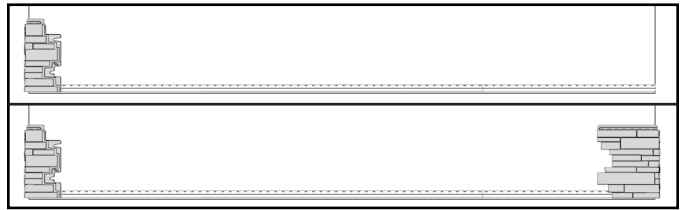

#### INSTALLING FULL TANDOSTONE PANELS:

- Place a TandoStone panel on starter strip to the right of the aLL-Pro Corner.
- Slide panel to the left, engaging the two side locks into the aLL-Pro Corner.
- Space TandoStone panel from aLL-Pro Corner according to the outdoor temperature as described on page 6.
- Once the panel has been properly spaced, fasten securely as described on page 6.
- Install all subsequent panels on this row until no additional full panels will fit.
- Based on the measurements for the corner layout determined on page 7, the final panel to be installed will be a Kut Panel. See page 11 for complete instructions for making a Kut Panel.

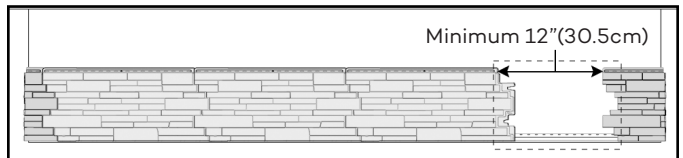

#### INSTALLING KUT PANELS:

- After a Kut Panel has been made (see page 11), and prior to installing it, remove the aLL-Pro Corner that was temporarily fastened on the right.
- Place the Kut Panel on the starter strip and slide to the left, engaging the two side locks into the adjacent TandoStone panel.
- Nail the Kut Panel in place with fasteners on both sides of the Kut Panel seam - as close as possible to the seam inside the nailing slot.
- Then, fasten into the center of nailing slot at far left end and far right end of the Kut Panel.
- Proceed to fasten at least every 8" (20.3cm).
- Do not place a fastener into any manufactured center nail hole of a Kut Panel.
- After installing Kut Panel, replace the aLL-Pro Corner on right side of wall and nail in place.

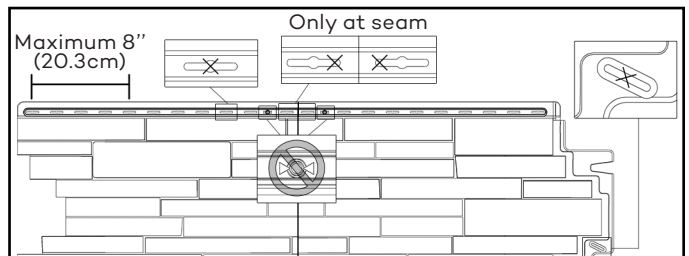

#### KUT PANEL INSTALLATION TIP:

- The Kut Panel will generally be the last panel installed in Rows 1 and 2. However, in rows 3 and above, assuming wall is square and true, Kut Panels may be pre-fabricated to allow for placement in varying positions across rows to ensure Kut Panel seams are staggered.

# TandoStone® aLL-Pro Corner™

## Installation Guide

### INSTRUCTIONS TO MAKE A KUT PANEL OR KUT PANEL XL:

- There are four steps to making a Kut Panel or Kut Panel XL - **Measure, Cut, Crimp,** and **Caulk.**
- **IMPORTANT** - Always use a Kut Kit when making a Kut Panel or Kut Panel XL. Each Kut Kit can make four (4) Kut Panels or Kut Panels XL.

#### • MEASURE:

- Measure the opening from the temperature gauge on the left panel to radius edge of the nailing slot of the aLL-Pro Corner on the right.
- This measurement is the length of Kut Panel to be made.
- Kut Panels must be a minimum of 12"(30.5cm) wide.
- Reminder: if the opening is not 12"(30.5cm) or more, choose an alternate corner layout as described on page 7.

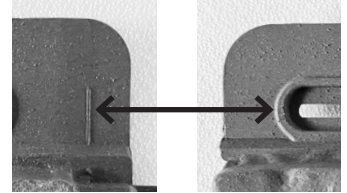

#### • CUT:

- When cutting for a Kut Panel, the side locks on both sides of panel must remain intact.
- Using a full panel, measure from left edge of nailing flange and mark at 9"(22.9cm).
  - **Always** cut through the mark precisely at 9"(22.9cm) to ensure panel side locks and hooks remain intact.
- Next, measuring from the right edge of the nailing flange, subtract 9"(22.9cm) from the total measurement of the needed Kut Panel.
- Mark panel at this length, cut through this mark.

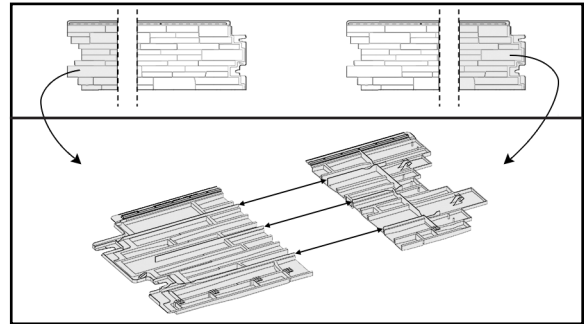

#### MEASUREMENT EXAMPLE:

- Assume a Kut Panel of 22"(55.9cm) is needed.
- Using full panel, measure from left, mark at 9"(22.9cm), and cut through mark.
- Then, measure from right side of panel, mark at 13"(33cm), and cut through mark.
- Your pieces of 9"(22.9cm) and 13"(33cm) will be combined to make the necessary panel width of 22"(55.9cm).
- The middle of the panel becomes waste.

#### • CRIMP:

- Place the two cut pieces together, face down, on a flat surface with horizontal ribs aligned and eliminate any gap between cut panel pieces.
- Place one (1) crimp plate at each of the 3 horizontal panel ribs.
- Ensure crimp plates lie flush over ribs. If there is a spine impeding the crimp plate lying flat, trim portion of the spine to enable crimp plates to lie flat.
- Using crimper tool or pliers, crimp/squeeze the crimp plates tightly to secure panels together.
- Ensure the teeth of the crimp plates seat securely into the horizontal ribs.

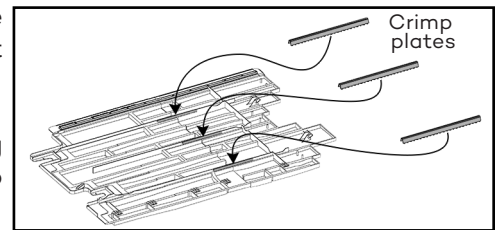

#### • CAULK:

- Using the color-matched caulk supplied in Kut Kit, place a bead of caulk 3/8"(1cm) wide over the seam and over the crimp plates to fill any spaces/openings.
- Make sure to apply caulking from the back with the tube nearly perpendicular to the panel.
- The assembly can be installed on the wall immediately.

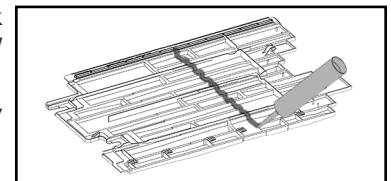

### KUT PANEL XL SPECIAL NOTES

- In certain applications, such as terminating into a window, door frame, or adjacent wall where corner layout cannot be adjusted, a Kut Panel XL (i.e., a Kut Panel over 40"(101.6cm) and less than 52"(132.1cm)) may be used.
- To fabricate a Kut Panel XL, follow the steps above for a Kut Panel except cut on left side of panel at 25"(63.5cm) instead of 9"(22.9cm).
- A Kut Panel XL should not be fabricated longer than 52"(132.1cm).

# **aLL-PRO CORNER™**

